

2025



Ersatzteile & Zubehör
Handels GmbH.

LINDNER

AKTION

Gültig von 5. 2. bis 2. 3. 2025



Ihr Partner, wenn
es um Ersatzteile geht!

Oberharrern 33
A-4691 Schlatt
Tel.: 0043 (0)7673 / 30703
Fax: 0043 (0)7673 / 30703-40
email: verkauf@oekoprofi.com

www.oekoprofi.com

Grammer Luftsitz Maximo L

- Luftfederter Komfortsitz 12V
- ohne Rückenverlängerung
- mit höhenverstellbaren und klappbaren Armlehnen
- Armlehnen-Länge 260 mm • Federweg: 100 mm
- Gewichtseinstellung manuell
- Höheneinstellung: 80 mm, stufenlos
- Längseinstellung: 210 mm
- Längs-Horizontal-Federung
- Lendenwirbelstütze mechanisch
- Rückenlehnen-Neigungsverstellung
- Sitzkissenbreite: 480 mm
- Stoffbezug, schwarz

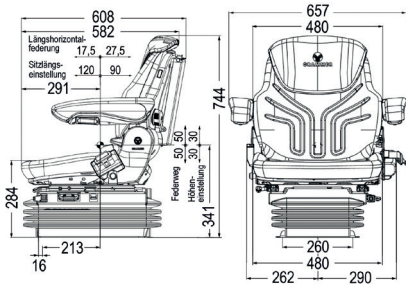

Zustellung € 30,-

Nr. Bezeichnung
G5300 Grammer Luftsitz MAXIMO L

€
~~799,00~~
719,00

Ökoprofi-Gesundheitssitz

- Längsverstellung 250 mm
- Rückenlehnen-Neigungsverstellung 30°-85°
- Höhenverstellung 80 mm
- Lendenwirbelstütze
- Gewichtseinstellung 50-130 kg
- Federweg 100 mm

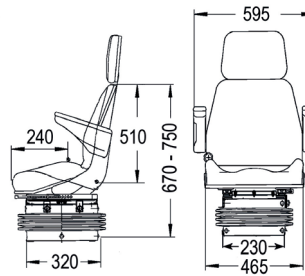

Nr.	Bezeichnung	€
53005	Sitz mechanisch Stoff schwarz	418,90 375,90
(ohne Armlehne, Kopfstütze und Sicherheitsgurt)		
53059	Armlehnenpaar verstellbar, zu 53005	89,90 74,90
53052	Kopfstütze	54,90 45,80
53005U	Sitzpolster Unterteil Stoff schwarz	88,90 74,10
53005O	Sitzpolster Oberteil Stoff schwarz	88,90 74,10

Komfort-Gesundheitssitz

mit Luftfederung Ökoprofi

- Längsverstellung 190 mm
 - Federweg 140 mm
 - Mit Hydraulik-Stoßdämpfer
 - Automatische Gewichts- und Höheneinstellung, 50 - 130 kg
 - Horizontal-Federung mit Dämpfer (35 mm Federweg)
 - Rückenlehne Neigungsverstellung 30°
 - Mechanische Lendenwirbelstütze
 - Polyurethan-Sitzkissen
 - verstellbare Armlehnen
 - Feuerfeste Stoffbeschichtung
 - Verlängerbare Rücklehne
 - Luftkompressor 12 V
- Aufbau: Alle Metallteile sind mit Elektrophorese grundiert und elektrostatisch einbrennlackiert.
Bolzen, Schrauben, Muttern, Unterlegscheiben und Ringe sind korrosionsbeständig.

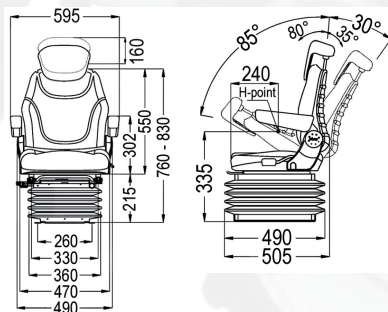

Nr. Bezeichnung
87630 Gesundheitssitz mit Luftfederung Ökoprofi
(12V Luftkompressor 9 A)
(ohne Armlehne, Rückenverlängerung und Sicherheitsgurt)

€
~~819,00~~
738,90

Zubehör

Nr. Bezeichnung

87633 Rückenverlängerung zu 87630

53059 Armlehnenpaar verstellbar, zu 87630

53061 Sicherheitsgurt

62835 Sitzpolster zu 87630



€
~~73,90~~ **61,60**
~~89,90~~ **74,90**
~~44,90~~ **37,40**
~~104,90~~ **87,40**

Universalsitz

- Federweg 100 mm
- Gewichtseinstellung stufenlos 40 - 130 kg
- Längsverstellung 150 mm

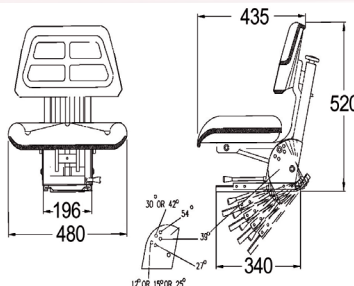

Nr.	Bezeichnung	€
12727	Sitz mechanisch gefedert mit verstellbarer Bodenplatte Bezug Kunstleder schwarz passend zu sehr vielen kleineren Traktoren	89,90 81,90
12727O	Oberteil zu 12727	51,90 43,30
12727U	Sitzpolster zu 12727	51,90 43,30
63320	Gasdruckdämpfer zu 12727	28,90 24,10

Universalsitz

- Großer Federweg von 90 mm
- Hydraulischer Stoßdämpfer
- Gewichtseinstellung 50 - 120 kg
- Einstellbare Grundplatte: 0, 11 und 20 Grad

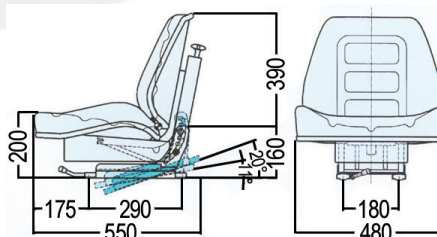

Nr. Bezeichnung
96490 Sitz mechanisch Ö 1050

€
~~196,90~~ **168,90**

Kraftstofffilter

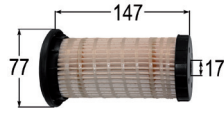

Nr.	Bezeichnung	verwendbar anstelle von	€	
84598	Kraftstofffilter	P917x / CAV296	3,90 3,30	
02742	Kraftstofffilter	P945X 1017 KX24 620 BF884 S8111NC 2436100	6,90 5,80	
02042	Kraftstofffilter	WK842/2 161500080043 3132428R2 1013 161500080043 WK8422 1012 KC18 5006 BF5587D S8500NR 2435100	8,50 7,10	
97125	Kraftstofffilter	WK842/2	15,60 13,00	
69678	Kraftstofffilter	WK842/1	10,90 9,10	
51840	Kraftstofffilter	BFU707	7,90 6,60	
61874	Kraftstofffilter	2656F853	49,90 41,60	
61873	Kraftstofffilter	62656F546	19,90 16,60	
08251	Kraftstofffilter	P707 1024 KX35 457 PF834 S7411N 2660900	4,90 4,10	
11267	Kraftstofffilter	P824X 1022 KX25 452 PF820S S6181N 2660200	7,50 6,30	
91865	Kraftstofffilter	26560163, 4225393M1	15,90 13,30	
61846	Kraftstofffilter	6516149M91	63,90 53,30	

Nr.	Bezeichnung	verwendbar anstelle von	€	
61844	Kraftstofffilter	3611274	58,90 49,10	

Ölfilter

Nr.	Bezeichnung	verwendbar anstelle von	€	
11259	Ölfilter	W-950.7 W9507 2022 OC42 308 BT237 S0420R 2315600	10,90 9,10	
51828	Ölfilter	W-723.3	8,50 7,10	
51835	Ölfilter	W-940.24	9,30 7,50	
60133	Ölfilter	W10050	20,60 17,20	

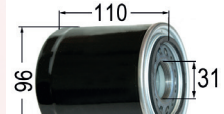
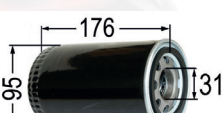
Hydraulikfilter

Nr.	Bezeichnung	verwendbar anstelle von	€	
53206	Hydraulik-Ölfilter	W9237 OC147	36,90 30,80	
51841	Hydraulik-Ölfilter	W951/5 OC70	22,90 19,10	
99374	Hydraulik-Ölfilter	735700733011, SPH94006,	43,90 36,60	

Luftfilter

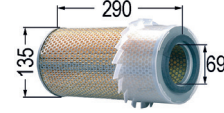
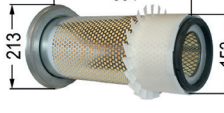
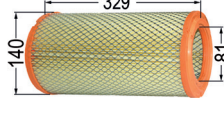
Nr.	Bezeichnung	verwendb. anst. von	€	
02717	Luftfilter	C-14179	23,90 19,90	
08283	Luftfilter	C18267	46,80 39,00	
14886	Luftfilter	C14200.1	23,90 19,90	

Nr.	Bezeichnung	verwendbar anstelle von	€	
94502	Luftfilter	3203035	36,90 30,80	
40704	Luftfilter	CF300	24,30 20,30	
40705	Luftfilter	C14200	32,20 26,80	
40706	Luftfilter	C15300	34,80 29,00	
40707	Luftfilter	CF400	29,90 24,90	
40708	Luftfilter	C16400	29,90 24,90	
51846	Luftfilter	CF-600	32,70 27,30	
51847	Luftfilter	CF-700	30,50 25,40	
51849	Luftfilter	C-13114.4	21,40 17,80	
61223	Luftfilter	CP25150	64,90 54,10	
69649	Kabinenfilter	CU2582	21,90 18,30	
94499	Kabinenluftfilter	CU31152, 3004510, SKL46222,	22,90 19,10	
61837	Kabinenluftfilter	3205712	36,90 30,80	
61840	Kabinenluftfilter	3204888	49,90 16,60	

Nr.	Bezeichnung	verwendbar anstelle von	€	
61838	Kabinenluftfilter	3204490	29,90 24,90	
61841	Kabinenluftfilter	3204890	34,90 29,10	
61224	Sekundärfilter	CF2120	38,90 32,40	
06271	Dieselfiltergehäuse einfach kpl.	2656615 / 883786M91	28,90 24,10	
84598	Kraftstofffilter	P917x / CAV296	3,90 3,30	
06969	Verschlusschraube 1/2" UNF		2,40 1,80	
06970	Hohlschraube 1/2" UNF		2,70 2,30	
11084	Dieselfiltergehäuse doppelt kpl.	2656818 / 1446891M91	52,90 44,10	
02721	Schauglas	26560111 / 1039071M1	6,90 5,80	
06275	Aludeckel für Dieselfilter		5,50 4,60	

Hydraulikpumpen

Nr.	Bezeichnung	cm³	€	
55319	Hydraulikpumpe verwendbar anstelle von: 510420006/ 510425010 passend zu 320, 350Sa, 550SA,620,SA450	8	176,90 147,40	
55318	Hydraulikpumpe verwendbar anstelle von: 510525010 passend zu Lindner 320,420, 1055,1450,1500,1600	11	179,00 149,20	
55320	Hydraulikpumpe verwendbar anstelle von: 0510625015 passend zu 450, 520, 550, 620, 1650, 1700	16	496,90 164,10	
90321	HD-Pumpe verwendbar anstelle von: 0510525339, 0510525345 Lindner 1650, 1700		223,50 186,30	
98278	HD-Pumpe re. verwendbar anstelle von: 0510725045, 0510725077, 0510725178, 3004918 passend zu Lindner 1700 Geotrac: 63, 64, 73, 74, 83, 84, 93, 94, 103		499,00 165,80	

Zusatzsteuergeräte

Nr.	Bezeichnung	€
50199	Zusatzsteuergerät zu System SB7 einfachwirkend und doppelwirkend verwendbar mit Schwimmstellung	386,90 338,90



94564	Dichtsatz kpl. passend zu Zusatzsteuergerät SB7 (50199)	24,90 18,30
-------	---	----------------------------------

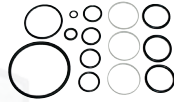

50205	Zusatzsteuergerät zu System SB23 re. und li. einfachwirkend und doppelwirkend verwendbar mit Schwimmstellung passend zu Lindner Geo-Trac	478,90 399,10
-------	--	------------------------------------

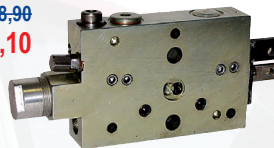

51580	Zusatzsteuergerät zu System SB23 LS load sensing doppelwirkend verwendbar mit Schwimmstellung gerastet vergleichbar Bosch 521610000, 521610003, 521610005, 521610007, 521510008, 521510011, 521610012, 521610017	599,00 499,20
-------	--	------------------------------------



Ventile

50214	Regelventil SRZ dient zur Regelung des Hubwerkes	699,00 618,90
-------	--	------------------------------------

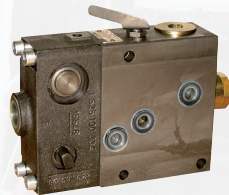

62857	Dichtsatz zu Hauptsteuergerät 50214	68,90 57,40
-------	--	----------------------------------



Elektrik

54761	Batterietrennschalter max. 150 A	18,90 14,90
-------	-------------------------------------	----------------------------------



09862	Batterietrennschalter Dauerbetrieb max. 100 A	9,90 8,30
-------	--	--------------------------------



54739	Batterietrennschalter Dauerbetrieb 12/24V max. 450-700	18,90 15,80
-------	--	----------------------------------



54740	Batterietrennschalter 75 A, mit Schlüssel zum Absperrn	35,90 29,90
-------	---	----------------------------------



00725	Batterieklemme plus 10 - 50 mm ²	2,50 2,10
-------	---	--------------------------------



00727	Batterieklemme minus 10 - 50 mm ²	2,50 2,10
-------	--	--------------------------------

09424	Schutzkappe zu Batterieklemme rechts	1,20 1,00
00709	Schutzkappe zu Batterieklemme links	1,20 1,00



99776	Gummikappe zu Anlasser A = 21 B = 18 C = 61 mm	3,30 2,80
-------	---	--------------------------------



99777	Gummikappe zu Anlasser A = 31 B = 36 C = 70 mm	4,40 3,70
-------	---	--------------------------------

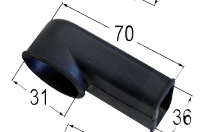

92907	Gummikappe zu Anlasser A = 20 B = 16 C = 57 mm	3,10 2,60
-------	---	--------------------------------



54554	Gummikappe zu Anlasser A = 19 B = 17 C = 68 mm	5,10 4,30
-------	---	--------------------------------



Leuchten

51712	Blink-Positionsleuchte re./li. Ø = 80 mm	35,90 29,90
-------	---	----------------------------------



passende Lampe:
1 x 00441, 1 x 51737

51713	Ersatzglas re./li. Blink-Positionsleuchte	17,90 14,90
-------	---	----------------------------------

51714	Schluss-Brems-Blinkleuchte Ø = 80 mm	13,90 11,60
-------	---	----------------------------------



passende Lampe:
1 x 00440, 1 x 51737

51716	Ersatzglas Schluss-Brems-Blinkleuchte	9,40 7,80
-------	---------------------------------------	--------------------------------

51695	Rückleuchte re. Kennzeichenbeleuchtung durch wechselbaren Einsatz	19,90 16,60
-------	---	----------------------------------

51696	Ersatzglas re. Kennzeichenbeleuchtung durch wechselbaren Einsatz	14,90 12,40
-------	--	----------------------------------



51697	Rückleuchte li. Kennzeichenbeleuchtung durch wechselbaren Einsatz	19,90 16,60
-------	---	----------------------------------

51698	Ersatzglas li. Kennzeichenbeleuchtung durch wechselbaren Einsatz	14,90 12,40
-------	--	----------------------------------

51702	Blink-Positionsleuchte re./li. passende Lampe: 1 x 00441, 1 x 00440	28,90 24,10
-------	--	----------------------------------

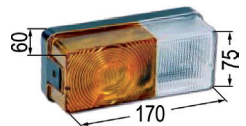

51703	Ersatzglas re./li. zu Blink-Positionsleuchte	19,90 16,60
-------	---	----------------------------------

51704	Schluss-Brems-Blinkleuchte re.	28,90
51705	Schluss-Brems-Blinkleuchte li. mit Kennzeichenbeleuchtung	28,90 24,10

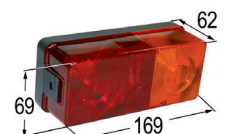

51706	Ersatzglas re. zu Rücklicht	19,90
51707	Ersatzglas li. o. Kennzeichenbeleuchtung	19,90
97420	Ersatzglas li. m. Kennzeichenbeleuchtung	19,90 16,60



Leuchten

Nr.	Bezeichnung	€		Nr.	Bezeichnung	€	
53931	Blink-Positionsleuchte re. 90 x 95 x 54	49,00 49,10		12334	Blink-Positionsleuchte kpl. re.	29,00 24,20	
53932	Blink-Positionsleuchte li. 90 x 95 x 54 passende Lampe: 1 x 51737, 1 x 00441	58,90 49,10		12335	Blink-Positionsleuchte kpl. li. passende Lampe: 1 x 00441, 1 x 00397	29,00 24,20	
53933	Ersatzglas re./li.	12,50 10,40		00464	Blink-Positionsleuchte kpl. re./li. passende Lampe: 1 x 00441, 1 x 00397	13,50 11,30	
61718	Blink-Positionsleuchte re. verwendbar anstelle von: 3226120R1, 04389586, 02377450, X830180037000	16,90 14,10		55487	Schluss-Blinkleuchte passende Lampe: 1 x 51738, 1 x 51739	20,90 17,40	
61719	Blink-Positionsleuchte li. verwendbar anstelle von: 3226119R1, 04389584, 02377448, X830180036000	16,90 14,10		51334	Brems-Positionsleuchte rot 82 x 82 mm passende Lampe: 1 x 00441, 1 x 51737	20,90 17,40	
53820	Schluss-Brems-Blinkleuchte re.	15,90 13,30		51151	Schluss-Brems-Blinkleuchte re.	16,90 14,10	
53821	Schluss-Brems-Blinkleuchte li. 90 x 85 x 50 mit Kennzeichenbeleuchtung Glas dreigeteilt passende Lampe: 2 x 00441, 1 x 00397	15,90 13,30		51152	Schluss-Brems-Blinkleuchte li. passende Lampe: 2 x 00441, 1 x 51737	16,90 14,10	
53822	Ersatzglas re. 90 x 85	15,90 13,30		53967	Blink-Positionsleuchte passende Lampe: 1 x 00441, 1 x 51737	16,90 14,10	
53823	Ersatzglas li. 90 x 85 mit Kennzeichenbeleuchtung	15,90 13,30		51155	Schluss Blinkleuchte Ø 80 passende Lampe: 1 x 51737, 1 x 51739	48,90 40,80	
53986	Schluss-Brems-Blinkleuchte re.	23,90 19,90		51169	Schluss Blinkleuchte mit Kennzeichenb. passende Lampe: 1 x 51737, 1 x 51739	56,90 47,40	
53987	Schluss-Brems-Blinkleuchte li. mit Kennzeichenbeleuchtung Glas dreigeteilt mit Schraube passende Lampe: 2 x 00441, 1 x 00397	23,90 19,90		51159	Blink-Positionsleuchte passende Lampe: 1 x 51737, 1 x 51739	54,90 45,80	
53988	Ersatzglas re.	22,90 19,10		51174	Rückleuchte Ø 60 passende Lampe: 1 x 51737	16,90 14,10	
53989	Ersatzglas li. mit Kennzeichenbeleuchtung	22,90 19,10		80594	Positionsleuchte re./li. rot passende Lampe: 1 x 51327	49,50 41,30	
53994	Schluss-Brems-Blinkleuchte re.	15,90 13,30		74893	Schlussleuchte rot-orange passende Lampe: 1 x 00440 1 x 51737	32,90 27,90	
53995	Schluss-Brems-Blinkleuchte li. 85 x 95 x 54 mit Kennzeichenbeleuchtung passende Lampe: 2 x 00441, 1 x 00397	15,90 13,30		74822	Schlussleuchte rot-orange mit Kennzeichenleuchte passende Lampe: 1 x 00440 1 x 51737	32,90 27,40	
53996	Ersatzglas re.	11,90 9,90		74894	Schlussleuchte rot mit Kennzeichenleuchte, passend zu vielen alten Traktoren passende Lampe: 1 x 00440 1 x 51737	32,90 27,40	
53997	Ersatzglas li. mit Kennzeichenbeleuchtung	11,90 9,90					
36558	Blink-Positionsleuchte re./li. Ø 80 passende Lampe: 1 x 51737, 1 x 51739	49,90 16,60					
09869	Blink-Positionsleuchte re./li. passende Lampe: 1 x 00441, 1 x 51737	12,90 10,80					
09859	Ersatzglas re./li. zu Blink-Positionsleuchte	6,40 5,10					

Hauptscheinwerfer

Nr.	Bezeichnung	€		Nr.	Bezeichnung	€	
02850	Scheinwerfer rund Ø 160 mm mit Gewinderohrbefestigung M16 passende Lampe: 1 x 00295, 1 x 00451	29,90 24,90		00792	Ersatzglas zu Einbauscheinwerfer	9,80 8,20	
51148	Fassung für Standlicht Kunststoff 2 Anschlüsse	2,30 1,90		90897	Gitter schwarz zu 01469/01470	9,90 8,30	
60816	Scheinwerfereinsatz 105 mm	23,90 19,90		90898	Gitter Chrom zu 01469/01470	15,90 13,30	
77865	Scheinwerfer rechts 130 mm	49,90 41,60		62952	Dichtung zu 01470	6,90 5,80	
77866	Scheinwerfer links 130 mm passende Lampe: 1 x 00295, 1 x 51742 mit Rohrbefestigung 24 mm	49,90 41,60		60881	Dachscheinwerfer klar H4	29,90 24,90	
96010	Adapter zu Scheinwerfer	17,90 14,90		37338	Einbauscheinwerfer H4 kpl. re./li. L=165 H=105, AL75338 / RE 56964 passende Lampe: 1 x 00373	35,90 29,90	
51143	Fassung für Standlicht Metall 1 Anschluss	2,20 1,80		53518	Scheinwerfer kpl. re./li. Breite 165, Höhe 105, LA= 130 mm verwendbar anst. von: 00075269010, 1693944M93 passende Lampe: 1 x 00373	35,90 29,90	
61388	LED Fassung für Standlicht	3,90 3,30		42019	Scheinwerfereinsatz re./li. Breite 162 mm, Höhe 107 mm, LA = 130 mm verwendbar anstelle von: 3550747M91 passende Lampe: 1 x 00295	21,50 17,90	
42014	Stecksocket für Lampe 3-polig	3,20 2,70		90913	Scheinwerfer re./li. Breite 165 mm, Höhe 108 mm, LA 99 mm verwendbar anstelle von: 3809346M91 passende Lampe: 1 x 00295	62,30 51,90	
93918	Stecksocket-Adapter	6,80 5,70		90914	Scheinwerfer re./li. Ø 140 mm, LA 105 mm verwendbar anstelle von: 4278938M92	134,90 112,40	
52903	Scheinwerfereinsatz mit Begrenzungslicht passende Lampe: 1 x 00373	36,90 29,90		01364	Scheinwerfereinsatz 12 V 45/40W verwendbar anst.: 5177846, 5126153 passende Lampe: 1 x 00295	28,90 24,10	
01469	Einbauscheinwerfer kpl. re./li. passende Lampe: 1 x 00439	74,90 62,40		03988	Scheinwerfereinsatz 12 V 45/40W L = 145, H = 90, mit Standlicht 12V 3W passende Lampe: 1 x 00295, 1 x 00441	55,90 46,60	
01470	Einbauscheinwerfer kpl. re./li. Einbaumaß = 132 x 132 passende Lampe: 1 x 00295	61,90 51,60		36549	Hauptscheinwerfer re./li. ohne Standlicht passende Lampe: 1 x 00295	36,90 30,80	

Scheinwerfer

Nr. 36550 **Bezeichnung** Hauptscheinwerfer H4 re./li.
passende Lampe:
 1 x 00373

€ ~~36,90~~
30,80

Nr. 51147 **Bezeichnung** Hauptscheinwerfer H4
 182 x 102 mm
passende Lampe:
 1 x 00373

€ ~~31,90~~
21,90

Nr. 93916 **Bezeichnung** Hauptscheinwerfer H4
 mit Standlicht
 185 x 85 mm
passende Lampe:
 1 x 00373, 1 x 00451

€ ~~58,90~~
49,10

Nr. 64744 **Bezeichnung** Arbeitsscheinwerfer
 verwendbar anstelle von:
 4271840M92,
 G931901115010
passend zu Lindner

€ ~~85,90~~
71,60

Nr. 63791 **Bezeichnung** Blinkleuchte vorne

- Leuchten-Bauart: Halogen
- Spannung: 12 V
- Leuchtfunktion: mit Blinklicht
- Schutzarten: IP5KX, IPX9K
- Prüfzeichen: ECE-R6, CCC
- mit Glühlampe
- ohne Schraube

verwendbar anstelle von:
 47626136, 3005597,
 280595290

€ ~~38,90~~
32,40

Nr. 63780 **Bezeichnung** LED-Schlussleuchte weiß

- Montageart: Anbau, Schraubanschluss
- Leuchten-Bauart: LED
- Spannung: 12 V
- Leuchtfunktion: mit Schlusslicht (LED), mit Bremslicht (LED)
- Steckerausführung: AMP
- Anzahl der LEDs: 16
- Kabellänge: 250 mm
- Gehäusertyp: Kunststoffgehäuse

verwendbar anstelle von:
 3005596, 280595320

€ ~~108,90~~
90,80

Nr. 63781 **Bezeichnung** LED-Schlussleuchte rot

- Leuchten-Bauart: LED
- Spannung: 12 V
- Leuchtfunktion: mit Schlusslicht (LED), mit Bremslicht (LED)
- Steckerausführung: AMP
- Anzahl der LEDs: 16
- Kabellänge: 250 mm
- Gehäusertyp: Kunststoffgehäuse

verwendbar anstelle von:
 280595310, 14065540

€ ~~145,90~~
96,60

Schalter

Nr. 90983 **Bezeichnung** Druckschalter Warnblinkanlage
 verwendbar anstelle von:
 133700580081

€ ~~18,90~~
15,80

Nr. 90984 **Bezeichnung** Druckschalter Drehleuchte
 12 V / 20 A
verwendbar anstelle von:
 133700580006

€ ~~20,90~~
17,40

Nr. 96280 **Bezeichnung** Druckschalter Arbeitsscheinwerfer
 verwendbar anstelle von:
 G210902111010, G210903020020,
 X830240357000, X830240091000

€ ~~20,90~~
17,40

Nr. 96286 **Bezeichnung** Druckschalter Arbeitsscheinwerfer
 verwendbar anstelle von:
 X830240356000, G117900111010

€ ~~21,90~~
18,30

Nr. 96289 **Bezeichnung** Druckschalter Scheinwerfer
 verwendbar anstelle von:
 G312900160011, G312900160010,
 X830240360000

€ ~~20,90~~
17,40

Nr. 90985 **Bezeichnung** Druckschalter Hauptscheinwerfer
 12 V / 1,2 W
verwendbar anstelle von:
 133700580004, 701/07800

€ ~~20,90~~
17,40

Nr. 90994 **Bezeichnung** Druckschalter Warnblinkanlage
 verwendbar anstelle von:
 01177148, 133700580002

€ ~~20,90~~
17,40

Nr. 54747 **Bezeichnung** Schalter für
 Warnblinkanlage
 Einbauöffnung 30 mm
 15, 30b, 30, 49, 49a, L, R

€ ~~9,90~~
8,30

Nr. 00414 **Bezeichnung** Lichtschalter
 4 Rasterstellungen
 mit Druckknopf für Hupe Ø = 22,5
 30, 49, 49a, 56a, 56b, 57/58

€ ~~23,30~~
19,40

Nr. 51694 **Bezeichnung** Bremslichtschalter

€ ~~7,00~~
5,80

Nr. 87205 **Bezeichnung** Zündlichtschalter
 Einbauöffnung 25 mm
 15, 30, 56, 56a, 56b, 58
verwendbar anstelle von:
 717638R91, 0342201009

€ ~~53,90~~
44,90

Nr.	Bezeichnung	€	
53689	Zündschloss Einbauöffnung 26 mm	49,90 41,90	
95995	Bosch Zündschloss mit Steckanschlüssen 15, 30, 56a, 56b, 58 verwendbar anstelle von: 0342201010	56,90 47,40	
53903	Startschalter Bosch Einbauöffnung 21,5 mm 17, 19, 30, 50a, 15/54, 58 verwendbar anstelle von: 0342316003	48,90 40,80	
53904	Startschalter Bosch Einbauöffnung 21,5 mm 15, 17, 19, 30, 50a verwendbar anstelle von: 0342315001	99,90 40,80	
53680	Ersatzschlüssel	6,90 5,80	
41981	Glühanlass-Schalter Einbauöffnung 16 mm verwendbar anstelle von: 1874535M3	25,90 21,60	
41983	Startschlüssel verwendbar anstelle von: 3813361M1	2,40 1,80	
92625	Lenkstockschalter verwendbar anstelle von: 3000301 passend zu Lindner 1450, 1500, 1600, 1650, 1700, 1750	108,90 90,80	
92642	Lenkstockschalter verwendbar anstelle von: 3004206,3004247 passend zu Lindner Geotrac: 50, 60, 70, 80, 100, Unitrac: 55, 65, 95	248,90 207,40	
80677	Lenkstockschalter passend zu Lindner Geotrac 53, 63, 65, 73, 75, 83, 85, 93, 103;	194,90 162,40	

Traktormeter			
Nr.	Bezeichnung	€	
64568	Traktormeter Drehrichtung links verwendbar anstelle von: 3000338 passend zu Lindner	129,00 107,50	
86743	Traktormeterwelle M18/M22x1,5 L = 540	45,90 38,30	
11948	Winkeltrieb verwendbar anstelle von: 2758346, 62758346 passend zu Lindner 1450, 1500, 1600, 1650, 1700, 1750;	25,90 21,60	

Hupe			
Nr.	Bezeichnung	€	
00437	Hupe 12 V	6,50 5,40	

Relais			
Nr.	Bezeichnung	€	
00707	Blinkerrelais 12 V, 21/99 Watt 3 Anschlüsse	8,90 7,40	
00708	Blinkerrelais 12 V 4 x 21 /8 x 21 W	18,50 15,40	
02101	Einschaltrelais 12V 20/30A	4,90 4,10	
99707	Einschaltrelais 12 V 70 A	12,90 10,80	

60972 Repsatz zu VDO-Display
passend zu Lindner
(welche das VDO- Instrument (LCD)
verbaut haben!);

Angelaufenes VDO Display vor der Reparatur → Klar lesbare Displayanzeige nach der Reparatur

89,90
72,90

Vorher **Nachher**

Aktion!

Handreiniger

Nr.: **66153K** **2 Handreiniger**
je 4 Kilo ohne
Dosierpumpe **€ 41,90**

2 Stück

Nr.: **67500K** **2 Handreiniger**
je 4 Kilo mit
1 Dosierpumpe **€ 49,90**

2 Stück

Starter

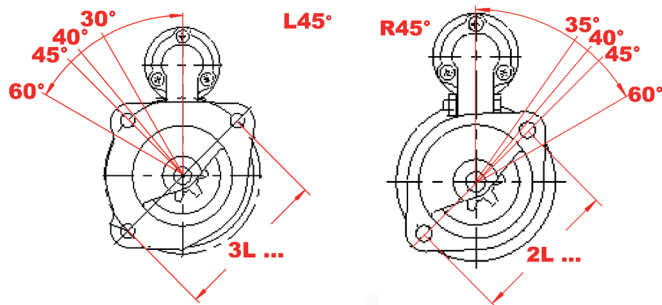

Nr.	Bezeichnung	Volt	KW	Zähne	€
41134	Starter Winkel L40° Löcher 3L, 127	12	2,8	10	269,00 224,20



43032	Starter Winkel R45° Löcher 3L 127	12	2,8	10	245,90 204,90
-------	--	----	-----	----	------------------------------------



51729	Starter Winkel R45°, Löcher 3L 146 (Lucas LRS190)	12	2,7	10	232,90 194,10
-------	---	----	-----	----	------------------------------------

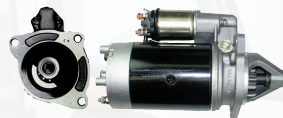

91607	Getriebestarter Winkel L30° Löcher 3L 127	12	3,2	10	274,00 228,30
-------	--	----	-----	----	------------------------------------



91609	Getriebestarter Winkel L42° Löcher 3L 127	12	3,2	9	276,90 230,80
-------	--	----	-----	---	------------------------------------



97411	Getriebestarter Winkel L40° Löcher 3L 127	12	4,2	10	279,90 233,30
-------	--	----	-----	----	------------------------------------



97435	Getriebestarter Winkel R45° Löcher 3L 127	12	4,2	10	299,00 249,20
-------	--	----	-----	----	------------------------------------



97436	Getriebestarter Winkel L42° Löcher 3L 127	12	3,2	10	264,90 220,80
-------	--	----	-----	----	------------------------------------



97438	Getriebestarter Winkel R45° Löcher 3L 146	12	3,2	10	269,00 224,20
-------	--	----	-----	----	------------------------------------



Nr. passend zu Type

91609	Getriebestarter 1700S, 1750, BF: 550, 620, Geotrac: 70, 85
97411	Getriebestarter 1750, Geotrac: 75, 95
97438	Getriebestarter 1048, 1055, 1450, 1500, 1600, 1650, 1700, Geotrac: 100, Unitrac: 60
97435	Getriebestarter Geotrac: 84, 94, 104, 114, 124
97436	Getriebestarter Geotrac: 64, 74, 50, 60, 63, 70, 73, 75, 80, 85
51729	Lindner alle 3 Zylinder
41134	Lindner alle 4 Zylinder
43032	Lindner GEO: 70, 75, 80, 85, 100
91607	Lindner GEO: 63, 83, 93, 103

Lichtmaschinen

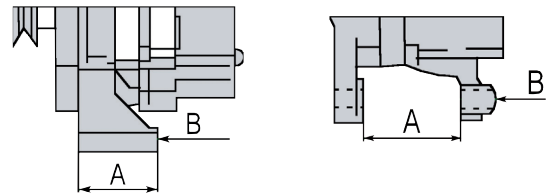

Nr.	Bezeichnung	Volt	Ampere	€
41154	Lichtmaschine ohne Riemenscheibe Ø 73 mm x 12,7 mm A = 80 mm, B = 10,2 mm	14 V	70 A	451,90 126,60

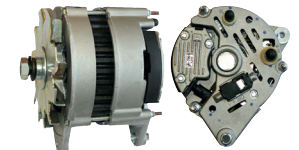

51724	Lichtmaschine mit Riemenscheibe einfach Ø 83 mm x 12,7 mm A = 27 mm, B = 10,2 mm	14 V	33 A	442,90 119,10
-------	--	------	------	------------------------------------

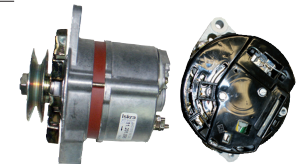

51725	Lichtmaschine mit Riemenscheibe einfach Ø 68 x 9,7 mm, A = 86,4 mm, B = 8,0 mm	14 V	55 A	435,90 113,30
-------	--	------	------	------------------------------------



69932	Lichtmaschine mit Riemenscheibe einfach Ø 91 x 12,7 mm, A = 27 mm B = 10,3 mm	14V	65A	454,90 129,10
-------	---	-----	-----	------------------------------------

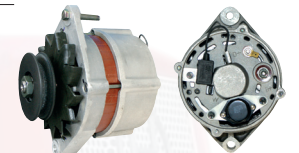

94843	Lichtmaschine	14V	100A	499,90 166,60
-------	----------------------	-----	------	------------------------------------



94844	Lichtmaschine	14V	120A	248,90 182,40
-------	----------------------	-----	------	------------------------------------



Nr. passend zu Type

51724	Lindner BF350,420,450,520,550,620,650,1048, 1055, 1065, 1450 (D3.152),1500 (D3.152S), Unitrac60
51725	Lindner 1450,1500(A3.152)
69932	Lindner 1600,1650(A4.236),1700(4.236)1750 (1004.4Unitrac75(Mercedes OM602 Turbo)
41154	Lindner Geotrac50,60,65,70,75,80,83,85,93,100, Unitrac55,65
94843	Lindner Geotrac: 64, 74, 104, 114, 124, Unitrac: 68, 78, 95;
94844	Lindner Geotrac: 84, 94

Lichtmaschine Gleichstrom

Nr.	Bezeichnung	€
61561	Gleichstromlichtmaschine 14V, 11A verwendbar anstelle von: 12203001 (passender Regler 97260)	208,90 174,10

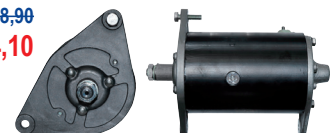

41854	Lichtmaschine 14V, 11A (passender Regler 41246)	95,90 79,90
-------	---	----------------------------------



78256	Lichtmaschine 14V, 22A (passender Regler 41246)	426,90 105,80
-------	---	------------------------------------



Zahnkranz

Nr.	Bezeichnung	€
40185	Zahnkranz 115 Zähne Ø = 341 mm	54,90 43,30



Regler

Nr.	Bezeichnung	€
54300	Regler Bosch 14V 11A	188,90 157,40



97260	Regler passend zu Bosch 14V - 11A	48,90 40,80
-------	---	----------------------------------



41246	Regler 12V zu Gleichstromlichtmaschine (41854), (engl. Ausführung)	65,90 54,90
-------	--	----------------------------------



Kühler

Nr.	Bezeichnung	€
63153	Kühler verwendbar anstelle von: 41326203 passend zu BF: 350S, 450S	415,90 346,60

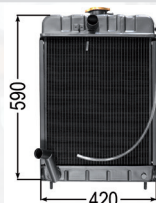

54417	Kühler passend zu BF420S/520S/ 1450/1500/1600	469,90 348,90
-------	---	------------------------------------

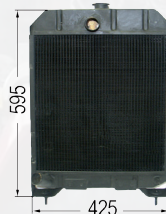

61028	Kühler verwendbar anstelle von: 3000135 passend zu 1650, 1700	529,90 440,80
-------	--	------------------------------------

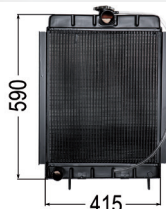

61032	Kühler verwendbar anstelle von: 3002779 passend zu 1650, 1700	689,90 574,20
-------	--	------------------------------------

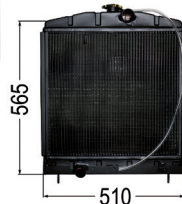

61031	Kühler verwendbar anstelle von: 3006040 passend zu Geotrac: 63, 73, 83, 83T, 93	658,90 549,10
-------	---	------------------------------------

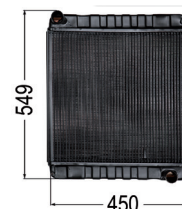

54319	Kühler passender Kühlerdeckel: 53731	249,90 207,50
-------	--	------------------------------------

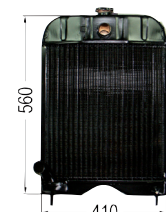

Wasserpumpen

Nr.	Bezeichnung	€
40524	Wasserpumpe verwendbar anstelle von: 748095M91	89,90 74,90



10161	Wasserpumpe Motortype: A3.152, AD3.152, AT3.152 verwendbar anstelle von: U5MW0023 / 747542M91	55,90 46,60
-------	--	----------------------------------



10150	Wasserpumpe Welle 19 mm verwendbar anstelle von: 41312143 / 3637411M91 / 36418321191	62,90 52,40
-------	---	----------------------------------



82999	Wasserpumpe (Welle 19 mm) verwendbar anstelle von: 4222071M91, U5MW0106	76,50 63,80
-------	--	----------------------------------



63709	Wasserpumpe mit Riemenscheibe Nabe 62,5 mm passend zu: 520, 1450, 1500, 1600;	87,00 72,50
-------	--	----------------------------------



54549	Gummiring für Armaturen 58/72	8,90 7,40
-------	-------------------------------------	--------------------------------



74818	Armaturenring innen 60 mm, außen 75 mm	8,90 7,40
-------	--	--------------------------------



Thermostate

Nr.	Bezeichnung	€
54443	Thermostat 82° C verwendbar anstelle von: AT22961, RE33705, 62485645, 62485653, 62485659, 62485666, 6485648, 1446127M91, 1446164M91, 1446165M91, 248 5666, 24855635, 828139M1, 3042303R92 passend zu BF: 350, 420, 450, 520, 550, 620, 650, 1450, 1500, 1600, 1650, 1700;	9,90 8,30



40558	Thermostat Motortype: A4.236, A4.248, AT4.236, 4.41, 1004.4, 1004.4T, A6.354.4, AT6.354, 1006.6, 1006.6T verwendbar anstelle von: 2485613 / 1447384M1 passend zu Lindner 1600, 1750, GEO: 70, 75, 80, Unitrac 95;	13,50 11,30
-------	--	----------------------------------

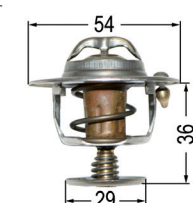

90786	Thermostat Ø = 70 Flansch, Schlauchanschl. 51 mm verwendbar anstelle von: 4133K509, 4225397M1, 2485C041, 64133L503, 4133L509, 4225397M1, 4225153M1 passend zu Geo 63, 64, 73, 74, 83, 93, 103	111,20 92,70
-------	--	-----------------------------------



Nr. Bezeichnung €
 92622 Thermostat 334,90
 verwendbar anstelle von: 279,10
 299992A1, 6299992A1



Nr. Bezeichnung €
 53783 Radbremszylinder 126,90
 105,80
 63048 Radbremszylinder Original FTE 269,00
 verwendbar anstelle von: 224,20
 133700340034



Heizelemente

Nr. Bezeichnung €
 80015 Heizelement 188,90
 zu Type: Geo Truck 63,73,83,93,103 157,40
 Kabelsatz 1m 80034 dazu
 verwendbar anstelle von: RE231



53788 Dichtsatz für Radbremszylinder 53783 29,90
 AD 28 mm 24,90

Kugelgelenke

Kabelsatz

Nr. Bezeichnung €
 80034 Kabelsatz 181,90
 Länge 1 m 151,60
 verwendbar anstelle von: MKMS1025



Nr. Bezeichnung €
 41313 Axialgelenke re-li. 49,90
 44,90

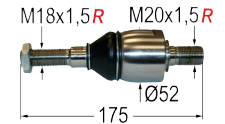

Kraftstoffpumpen

Nr. Bezeichnung €
 02106 Dieselpumpe 33,50
 Motortype: A4.212,A4.236,A4.248,AT4.236 27,90
 verwendbar anstelle von: 2641728,
 3637290M91, 62641709, 62641725,
 2641A071, 3641402M91,
 4222108M91, ULPK0001, 2641728
 passend zu BF: 550, 620, 1650, 1700;



59395 Axialgelenke 64,60
 verwendbar anstelle von: AL39320 53,80

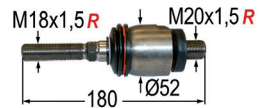

02111 Dieselpumpe 33,90
 Motortype: AD3.152 28,30
 verwendbar anstelle von: 2641808,
 4222090M91, 62641704, 62641808,
 6ULPK0004, ULPK0004, 1447582M91,
 2641712, 3637292M91
 passend zu 1450, 1500, 1600,
 GEO: 50, 60; Unitrac: 55, 60, 65;



54404 Axialgelenke 59,50
 verwendbar anstelle von: 1966127C1/ 1-33-741-675 49,60



86260 Kraftstoffpumpe 154,90
 verwendbar anstelle von: ULPK0038, 129,10
 4226144M1, 4226937M9
 passend zu Geotrac 83, 93, 103



80187 Spurstangengelenk 79,90
 passend zu Geo, 50,60,70,80,100, 66,60
 65,75,85,63,73,83,93



86262 Kraftstoffpumpe 154,90
 verwendbar anstelle von: 129,10
 ULPK0039, 4226994M1,
 4226625M91, 4132A016,



41310 Spurgelenk Lenkzylinder 37,90
 verwendbar anstelle von: 3427168M2 31,60



10320 Gelenk 8,50
 ID 20 mm, AD 35 mm 7,10
 verwendbar anstelle von: 9956707



Bremsen

Nr. Bezeichnung €
 53778 Bremsbacke 52,90
 (hydraulisch) 44,90



54246 Kugelgelenk re. 86,90
 verwendbar anstelle von: 133743305, 133743306,
 135700430707, 133743301 72,40

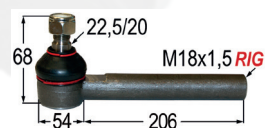

53779 Bremsbacke 58,90
 49,90



96270 Spurstangengelenk re. 98,20
 verwendbar anstelle von: 133700430704, 133700430706,
 133700430722, 133700430723,
 133700430725 81,80



54588 Kugelgelenk li. 83,90
 für Spurstange 69,90
 verwendbar anstelle von: 247523A1/ 340483A1



54589 Kugelgelenk li. u. re. 101,10
 gerade, für Spurstange, 84,30
 starre Achse
 verwendbar anstelle von: 411904A1

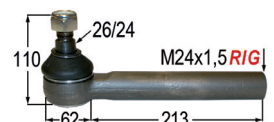

Axialgelenke für verschiedene Achsen

Nr.	Bezeichnung	€	Abbildung
54415	Axialgelenk passend zu Carraro Achse	59,90 44,90	
54416	Axialgelenk passend zu Carraro Achse	64,90 51,60	
41314	Axialgelenk passend zu Carraro Achse, ZF APL345	56,90 47,40	
54418	Axialgelenk passend zu Carraro Achse	74,90 62,40	
54419	Axialgelenk passend zu ZF APL325,330,335,2025	70,40 58,70	
54405	Axialgelenk re./li. verwendbar anstelle von: 33743011	72,70 60,60	
52682	Axialgelenk passend zu Carraro Achse	74,40 55,90	
77565	Axialgelenk verwendbar anstelle von: AL168703/ AL68253 passend zu ZF APL350	92,90 77,40	
77559	Axialgelenk passend zu Carraro Achse	58,90 49,10	
62950	Axialgelenk verwendbar anstelle von: AL220297	108,90 90,80	
54585	Axialgelenk verwendbar anstelle von: 1-33-743-613	78,30 65,30	

Staubschutz

Nr.	Bezeichnung	€	Abbildung
64570	Staubschutz 19 / 48 / 25	8,90 7,40	

Kotflügel

Nr.	Bezeichnung	€	Abbildung
87663	Universal-Kotflügel vorne re./li. für Oldtimer	63,90 53,30	

Aufkleber

Nr.	Bezeichnung	€	Abbildung
64895	Aufkleberpaar passend zu Lindner 9 PS	59,90 49,90	
64896	Aufkleberpaar passend zu Lindner BF 250 A	39,90 33,30	

Abstellseilzüge

Nr.	Bezeichnung	€	Abbildung
00642	Abstellseilzug L = 1200 mm	10,40 8,70	
00644	Abstellseilzug L = 2000 mm	12,20 10,20	

Dichtungen

Nr.	Bezeichnung	€	Abbildung
40337	Ölwannendichtung Motortype: AD3.152, AT 3.152 verwendbar anstelle von: 09999967 / 3688V003	16,90 14,10	
40360	Ölwannendichtung Motortype: A4.212, A4.236, AT4.236, A4.248 verwendbar anstelle von: 36815721 / 3638519M1	16,70 13,90	
11658	Zylinderkopfdichtsatz Motortype: A3.152 verwendbar anstelle von: 4222562M91	48,90 40,80	
11659	Zylinderkopfdichtsatz Motortype: AD3.152, AT3.152 verwendbar anstelle von: U5LT0038 / 4222480M91	44,90 37,40	
11660	Zylinderkopfdichtsatz Motortype: AD4.203 verwendbar anstelle von: 82907 / 4222920M91	47,70 39,80	

Motordichtsätze

Nr. **40397** **Bezeichnung** **Zylinderkopfdichtsatz**
 Motortype: A4.212,A4.236,A4.248
verwendbar anstelle von:
 U5LT0065 / 3638983M91

€
~~38,90~~
32,40

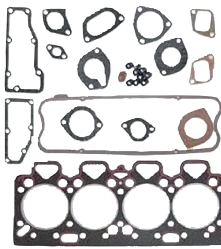

11661 **Motordichtsatz unten**
 Motortype: A3.152
verwendbar anstelle von:
 4222817M91

€
~~23,90~~
19,90



11662 **Motordichtsatz unten**
 Motortype: AD3.152 AT3.152
verwendbar anstelle von:
 4222815M91

€
~~24,90~~
20,80

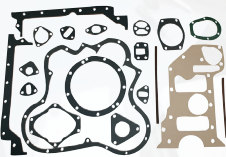

11663 **Motordichtsatz unten**
 Motortype: AD4.203 bis 29C1083
verwendbar anstelle von:
 4222928M91

€
~~23,90~~
19,90



Motorreparaturatz

bestehend aus: Kolben,
 Büchsen, Kolbenringe,
 Kolbenbolzen, Pleuellager,
 Kopfdichtung und Entlüßersatz

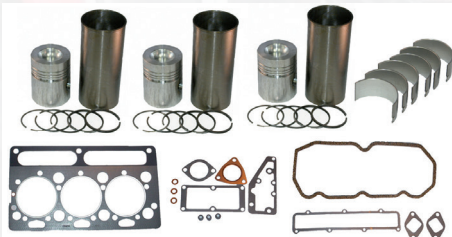

Nr.	Bezeichnung	Aktion €
MR6	Motorrep.-Kit Ø 91,49 passend zu Motor A3.152	268,90
MR7	Motorrep.-Kit Ø 91,49 passend zu Motor AD3.152	268,90
MR8	Motorrep.-Kit Ø 91,49 passend zu Motor A4.203	334,90
MR9	Motorrep.-Kit Ø 91,49 passend zu Motor AD4.203	334,90

Öldruckschalter

Nr. **53730** **Bezeichnung** **Öldruckschalter M10x1**

€
~~6,90~~
5,80



03697 **Öldruckschalter**
 Gewinde 1/8" BSP
verwendbar anstelle von:
 3599307M91

€
~~6,90~~
5,80



94504 **Öldruckschalter**
verwendbar anstelle von: 62848062
passend zu 1450, 1500, 1600, 1650, 1700
 Geotrac: 63, 70, 73, 74, 75, 80, 83, 93, 103

€
~~19,90~~
16,60



Kupplung

Nr. **55900** **Bezeichnung** **Doppelkupplung 250/225**
 23 x 29 mm, 10 Nuten,
 46 x 50 mm, 8 Nuten
passend zu 420S,520S,BF45,450

€
~~1039,00~~
865,80



Nr. **55902** **Bezeichnung** **Ausrücklager 100 x 57 mm**
 57 x 75 mm
verwendbar anstelle von:
 6094211, 500021120
passend zu Lindner 420, 520,
 BF: 30, 35, 45, 350, 420, 450;

€
~~174,90~~
145,80



55903 **Doppelkupplung 280/280**
 46 x 50 mm, 8 Nuten
passend zu Lindner 520,
 620, 1048, 1055, 1065

€
~~899,00~~
749,20



55904 **Kupplungsscheibe 280**
 23 x 29 mm,
 10 Nuten

€
~~274,90~~
229,10



55942 **Kupplungsscheibe**
 Ø 225 mm
 10Z/23x29

€
~~99,00~~
82,50



93666 **Drucklager AD = 102, ID = 65, S = 17 mm**
verwendbar anstelle von: 786532R91
passend zu Lindner 4-Zylinder

€
~~62,00~~
51,70



55990 **Ausrücklager 40 x 73 mm**
verwendbar anstelle von:
 1209160725

€
~~79,90~~
66,60



91992 **Feder**
 zu Ausrücklager 55990

€
~~7,90~~
6,60



Lüftermotoren

Nr. **97310** **Bezeichnung** **Lüftermotor**
verwendbar anstelle von:
 3200435
passend zu Lindner
 1450, 1500, 1600, 1650,
 1700, 1750
 Kabine A: 1265

€
~~278,90~~
232,40



97311 **Lüftermotor-Heizung**
verwendbar anstelle von:
 3004200
passend zu Lindner
 64, 74, 84, 94 Geotrac: 50,
 60, 63, 73, 83, 93, 103

€
~~198,90~~
165,80



Türschlösser

Nr. **93895** **Bezeichnung** **Türschloss re.**
verwendbar anstelle von:
 1-34-702-970, AL58548

€
~~56,90~~
47,40



93896 **Türschloss li.**
verwendbar anstelle von:
 134702970, AL58549

€
~~56,90~~
47,40



Scheibenwischer

Nr. Bezeichnung €
 12723 Wischermotor 12V 85° 68,90
 konische Aufnahme A = 42 mm 57,40

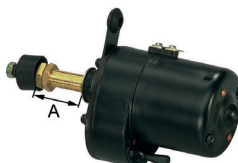

Nr. Bezeichnung €
 12459 Wischermotor 12V 110° 67,90
 zylindrische Aufnahme 56,60



01340 Wischermotor 12V 105° 68,90
 konische Aufnahme A = 46 mm 57,40

93958 Wischermotor 24V 85° 110,90
 zylindrische Aufnahme 92,40
 A = 61 mm

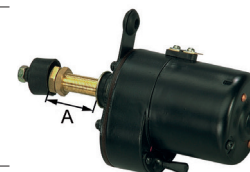

01311 Wischerarm L = 400/500 16,90
 verstellbar konische Aufnahme 14,10



01308 Wischerarm L = 300/400 17,90
 verstellbare zylindrische Aufnahme 14,90



01283 Wischerblatt L = 400 mm zu 01311 8,90
 7,40

01284 Wischerblatt L = 500 mm zu 01311 8,90
 7,40

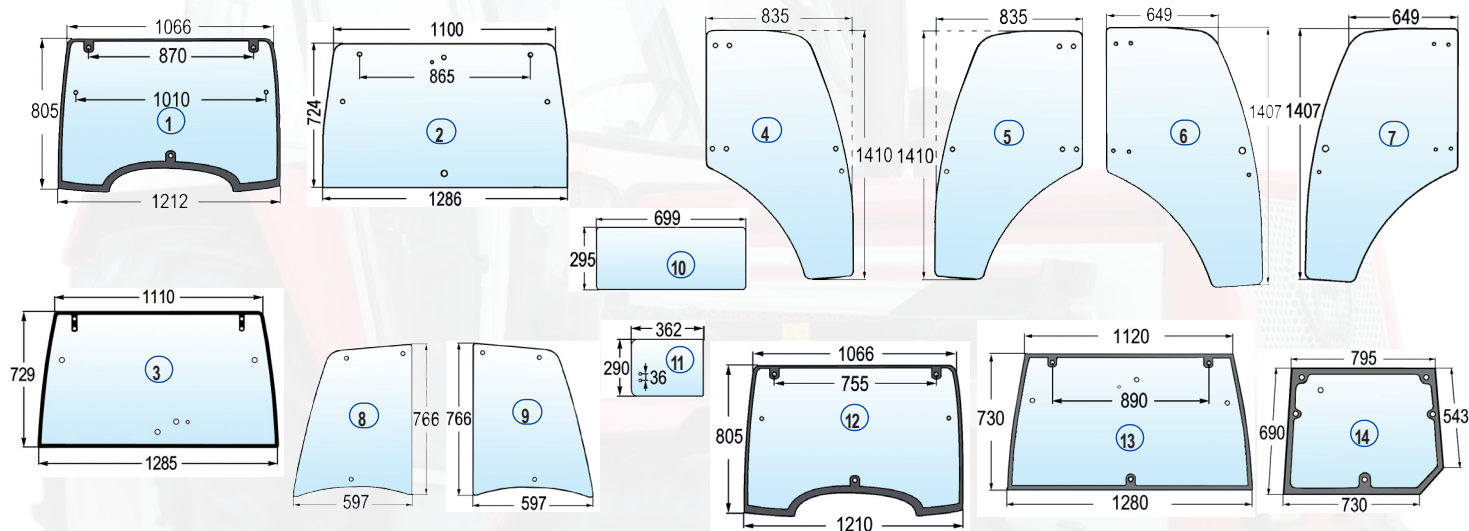

Traktorscheiben

passend zu Lindner Kabine Geotrac: 50, 60, 63, 65, 70, 73, 75, 80, 83, 85, 90, 93, 100, 103, 104, 114, 124;

Nr.	Bezeichnung	Pos.	verwendbar anstelle von	Bemerkung	€
90796	Frontscheibe	1	3203100		249,00 182,50
52918	Heckscheibe	2	3203101		158,90 132,40
60480	Heckscheibe	3	3006155		199,00 165,80
90265	Türscheibe re.	4	3203412	ab BJ 5/2001	199,90 166,60
90266	Türscheibe li.	5	3203411	ab BJ 5/2001	199,00 165,80
80058	Türscheibe re.	6	3203102	bis BJ 4/2001	199,00 165,80
80059	Türscheibe li.	7	3203103	bis BJ 4/2001	199,00 165,80
90820	Seitenscheibe re.	8	3203108		128,90 107,40
90821	Seitenscheibe li.	9	3203107		128,90 107,40
77708	Heckscheibe unten	10	3203106	fest	36,90 30,80
90819	Heckscheibe unten	11	3203137	Schiebefenster	54,90 45,80

passend zu Lindner Kabine Geotrac: 64, 74, 84, 94

94547	Frontscheibe	12	3204883		258,90 215,80
90822	Front-/Heckscheibe	13	3204882	getönt	476,90 147,40

passend zu Lindner Kabine Geotrac: 64, 74, 84, 94, 104, 114, 124

90824	Heckscheibe	14	3204508		198,90 165,80
-------	-------------	----	---------	--	--------------------------

Traktorscheiben

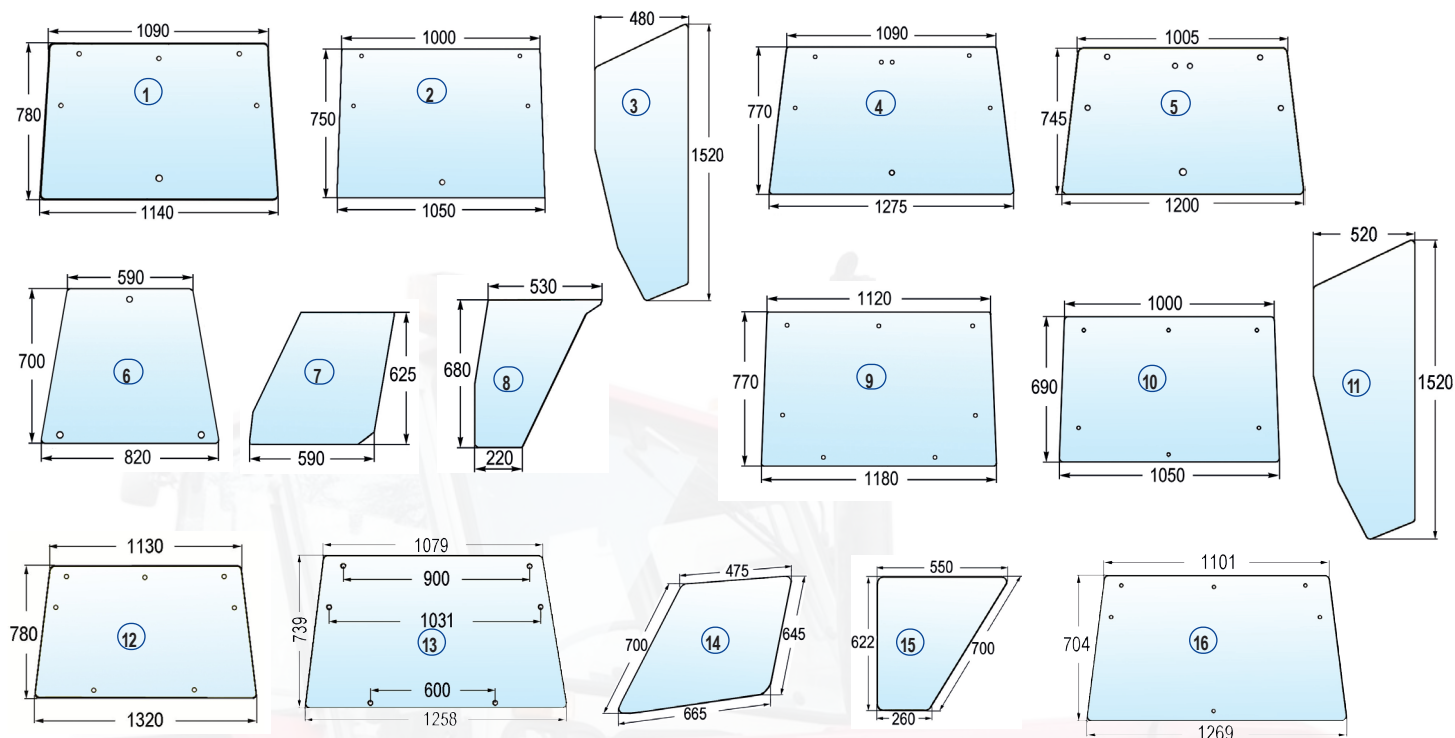

passend zu Lindner Modul Kabine 1048, 1055, 1065, 1450, 1500, 1600, 1700

Nr.	Bezeichnung	Pos.	verwendbar anstelle von	Bemerkung	€
51364	Frontscheibe	1	3200550		131,90 109,90
93244	Heckscheibe	2	3200551		139,90 116,60
80546	Türscheibe re./li.	3	3200547		178,90 166,60

passend zu Lindner Kabine Compact A 206: 1450, 1500, 1600

93239	Frontscheibe	4	3200560		149,90 124,90
77707	Heckscheibe	5	3200566	mit 2 Bohrungen für Wischer	108,90 87,40
93240	Seitenscheibe	6	3200562		98,90 82,40
93242	Türscheibe oben	7	3200563		68,90 57,40
93241	Türscheibe unten	8	3200564		63,90 53,30

passend zu Lindner A 1065, 1165 Kabine: 1600, 1650, 1700

53713	Frontscheibe	9	3200346		125,90 104,90
77705	Heckscheibe	10	P0065252 / 3200345		106,90 89,10
77706	Türscheibe re./li.	11	3200348		168,90 140,80

passend zu Lindner Kabine A1265: 1600, 1650, 1700, 1750

90794	Frontscheibe	12	3200370		188,90 157,40
80060	Frontscheibe	13	3201360	Hochdachkabine	148,90 124,10
90795	Türscheibe oben	14	3200373		86,90 72,40
90817	Türscheibe unten	15	3200374		78,90 65,80
77704	Heckscheibe	16	3200369		138,90 115,80

Gasdruckfedern

Nr. Bezeichnung €
 76724 Gasdruckfeder zu Motorhaube
 verwendbar anstelle von: 3003524 **20,90**
 passend zu Geotrac 50-100 **17,40**

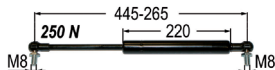

76725 Gasdruckfeder **20,90**
 verwendbar anstelle von: **17,40**
 3005006 / 218865

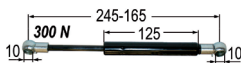

76726 Gasdruckfeder **20,90**
 verwendbar anstelle von: **17,40**
 3203117 / 218614

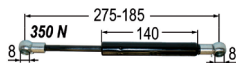

76727 Gasdruckfeder **30,50**
 verwendbar anstelle von: **25,40**
 3200573 / 615386



Fahrzeugspiegel

Nr. Bezeichnung €
 00742 Ersatzspiegel **15,90**
 180 x 230 mm **13,30**
 für Stange 18 -19 mm



52698 Spiegel **27,90**
 186 x 318 mm **23,30**
 für Stange 14-20 mm



52701 Ersatzglas 176 x 308 mm **13,50**
11,30



03112 Spiegel re. kpl. mit Haltestange **39,90**
33,30



03113 Spiegel li. kpl. mit Haltestange **39,90**
33,30

03114 Ersatzspiegel 140 x 235 mm **18,60**
15,50

80773 Spiegel **12,90**
 265 x 165 mm **10,80**
 für Stange 13 -16 mm



60537 Spiegel **9,90**
 232 x 145 mm **8,30**
 für Stange 10 mm



52676 Spiegel 150 x 260 mm **33,90**
 für Stange 10-12 mm **28,30**
 verwendbar anstelle von:
 3221522R2 / E178810150019
 3200397 620026150 511523112H



93872 Spiegel 305 x 183 mm **29,90**
 mit 16 mm Schelle **24,90**
 verwendbar anstelle von:
 134677017, 3203315



93873 Befestigungssatz zu 93872 **14,90**
 für 18 und 22 mm Stange **12,40**



93874 Ersatzglas 290 x 170 mm **16,90**
 zu Spiegel 93872 **14,10**
 verwendbar anst. von: 134777042, 3203316
 passend zu zu Lindner Geo
 ohne Teleskop-Spiegelhalter

Nr. Bezeichnung €
 64440 Spiegelhalter re. **198,90**
 verwendbar anstelle von: 134677083, **165,80**
 134677014, 3006182, E551542

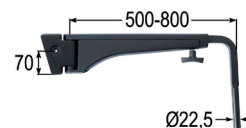

64441 Spiegelhalter li. **198,90**
 verwendbar anstelle von: **165,80**
 134677082, 134677013,
 3006045, E551543

93878 Spiegel 12V beheizt 314 x 226 mm **68,90**
 mit 18 u. 22 mm Spiegel **57,40**



93880 Ersatzglas 12V beheizt 300 x 213 mm **27,20**
 zu Spiegel 93878 **22,70**
 passend zu Lindner Geo
 ohne Teleskop-Spiegelhalter



52680 Spiegel **30,90**
 157 x 247 mm **25,80**
 für Stange 14-20 mm



52696 Spiegel **27,90**
 183 x 375 mm **23,30**
 für Stange 14-20 mm
 verwendbar anstelle von: G198810151010



52698 Spiegel 186 x 318 mm **27,90**
 für Stange 14-20 mm **23,30**



52701 Ersatzglas 176 x 308 mm **13,50**
11,30



62974 Spiegel re.-li. **99,90**
 382 x 232 x 121 mm **83,30**
 verwendbar anstelle von: 3010662,
 ACV0805960, 11068341, 3728075,
 21D5441710, 42154H3480, 1000386860

63976 Ersatzglas oben zu Spiegel 62974 **67,90**
 verwendbar anst.: F743810150010 **56,60**

95631 Ersatzglas unten **51,90**
 92 x 178 mm **43,30**
 zu Haupt-Nahbereichsspiegel



62975 Spiegel links 465 x 231 x 143 mm **128,90**
 verwendbar anstelle von: 3010850 **107,40**



62976 Spiegel rechts 465 x 231 x 143 mm **128,90**
 verwendbar anstelle von: **107,40**
 3010851, 1000379630

63976 Ersatzglas oben **67,90**
 zu Spiegel 62975 & 62976 **56,60**
 verwendbar anst. von: F743810150010

63977 Ersatzglas unten zu Spiegel re. 62976 **49,90**
41,60



63978 Ersatzglas unten zu Spiegel li. 62975 **49,90**
41,60

63477 Haupt-Nahbereichsspiegel **68,90**
 441 x 228 mm **57,40**

- Hauptspiegel (großer Spiegel): 287x 228 mm
- Radius Hauptspiegel (großer Spiegel): 1200
- Nahbereichsspiegel (kleiner Spiegel): 154 x 210 mm
- Radius Nahbereichsspiegel (kleiner Spiegel): 300
- Befestigungssockel Ø: 15 - 32 mm

63615 Ersatzglas 287 x 228 mm zu 63477 **18,90**
15,80

63616 Ersatzglas 154 x 210 mm zu 63477 **19,90**
16,60



Fahrzeugspiegel

Nr.	Bezeichnung	€
52704	Spiegel 140 x 210, für Stange Ø = 10 mm	19,90 16,60



52706	Spiegel 140 x 210, für Stange Ø = 12 mm	26,90 22,40
-------	--	----------------------------------



52708	Spiegel 140 x 250 mm für Stange Ø = 10/12 mm passend zu Mauser	31,90 26,60
-------	--	----------------------------------



53715	Ersatzglas 140 x 250 zu 52708	45,90 13,30
-------	---	----------------------------------

Schalldämpfer

Nr.	Bezeichnung	L	Ø	€
04095	Schalldämpfer verwendbar anstelle von: 192540091 passend zu Plus Serie 540, 650, 658, 760, 768	1160	73	84,90 70,80



52748	Flanschdichtung zu Auspuff verwendbar anstelle von: 407110021			2,90 2,40
-------	---	--	--	--------------------------------

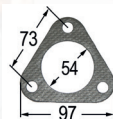

04062	Schalldämpfer verwendbar anst. von: 33700540157 passend zu 8045,8055, 8060,8070,8075, 8080,8090,9090	1280	60	112,90 94,10
-------	--	------	----	-----------------------------------



52750	Flanschdichtung zu Auspuff			4,30 3,60
-------	-----------------------------------	--	--	--------------------------------

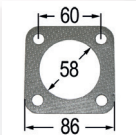

54334	Auspuffklappe verwendbar anstelle von: 192540051	43-49 mm		13,90 11,60
-------	--	----------	--	----------------------------------



Landmaschinen Farbtöne

Mipa Kunstharzlacke, beste Qualität -
sehr gute Farbdeckung, schnell trocken,
hoher Glanz, sehr widerstandsfähig.
(Mindestmenge 1 kg)
**Achtung: Die Rücklieferung von
Lacken ist nicht möglich!**

Preis per kg	€ 16,90 Aktion 14,90
--------------	---



Passend zu BF 14, 22, 25, 35, 45

Best. Nr.	Farbe	RAL Nr.
904146	Fehgrau	7000
50550	Rot	3000
50548	Weiß	9018
904122	Grasgrün	6010

Passend zu BF 250, 320, 3205,350, 420, 450, 520, 550, 620, 650, 1048, 1055, 1065

Best. Nr.	Farbe	RAL Nr.
50550	Rot	3000
50548	Weiß	9018

Passend zu 1450, 1500, 1600, 1650, 1700, 1750

Best. Nr.	Farbe	RAL Nr.	Verwendung
50550	Rot	3000	Plattform / Kotflügel / Dachschale
50548	Weiß	9018	Felgen / Kabinenrahmen
50549	Dunkelgrau	7021	Fahrgestell (ab Bj. 89)
50551	Gelborange	2000	Kommunal

Passend zu Geotrac Serie 1 & 2: 650 - 60 - 65- 70 - 75 - 80- 85 - 100

Best. Nr.	Farbe	RAL Nr.	Verwendung
50550	Rot	3000	Kotflügel, Kabine, Frontmaske
50549	Dunkelgrau	7021	Fahrgestell
50548	Weiß	9018	Felgen
904158	Grau	7011	Frontmaske
50554	Schwarz	9005	Batteriekasten
50551	Gelborange	2000	Kommunal (bis Bj. 2000)
904045	Orange	2011	Kommunal (ab Bj. 2001)

Passend zu Geotrac Serie 3: 663 - 73 - 83 - 93 - 103

Best. Nr.	Farbe	RAL Nr.	Verwendung
50550	Rot	3000	Kotflügel, Kabine, Frontmaske
50549	Dunkelgrau	7021	Fahrgestell
50548	Weiß	9018	Felgen
904158	Grau	7011	Frontmaske
50554	Schwarz	9005	Batteriekasten
904045	Orange	2011	Kommunal

Passend zu Serie 4

Best. Nr.	Farbe	RAL Nr.	Verwendung
50550	Rot	3000	Kotflügel, Kabine, Frontmaske
50549	Dunkelgrau	7021	Fahrgestell
50548	Weiß	9018	Felgen
904158	Grau	7011	Frontmaske
50554	Schwarz	9005	Batteriekasten
904045	Orange	2011	Kommunal

Passend zu Transporter T 3500

Best. Nr.	Farbe	RAL Nr.	Verwendung
50550	Rot	3000	Kotflügel, Plattform, Dachschale
50549	Dunkelgrau	7021	Fahrgestell
50548	Weiß	9018	Felgen, Kabinenrahmen

Passend zu Unitrac Serie 2

Best. Nr.	Farbe	RAL Nr.	Verwendung
50550	Rot	3000	Kabine
50549	Dunkelgrau	7021	Fahrgestell
904166	Graphitgrau	7024	Kotflügel, Frontmaske
50548	Weiß	9018	Felgen, Dach
50554	Schwarz	9005	Batteriekasten
904045	Orange	2011	Kommunal

Passend zu Lintrac

Best. Nr.	Farbe	RAL Nr.	Verwendung
904047	Signalrot	3001	Kotflügel, Kabine, Motorhaube
50548	Weiß	9018	Felgen
904166	Graphitgrau	7024	Kotflügel, Frontmaske
50554	Schwarz	9005	Batteriekasten
904045	Orange	2011	Kommunal

Passend zu Traktoren mit Motor Jenbacher JW

Best. Nr.	Farbe	RAL Nr.
904146	Fehgrau	7000
904048	Purpurrot	3004
904122	Grasgrün	6010

Sonstige

Best. Nr.	Farbe	RAL Nr.	Verwendung
50558	Grau		Grundierung
904087	Enzianblau	5010	Frontlader / Seilwinde